

COYA CARRIER

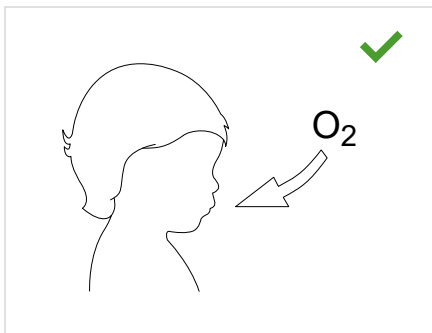

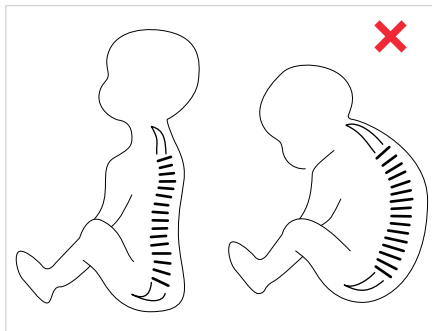

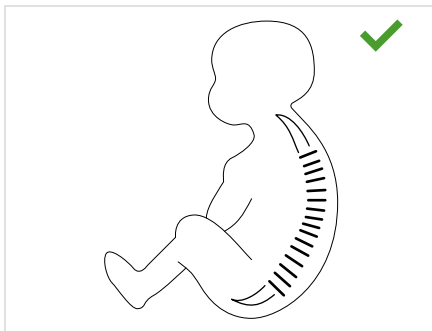

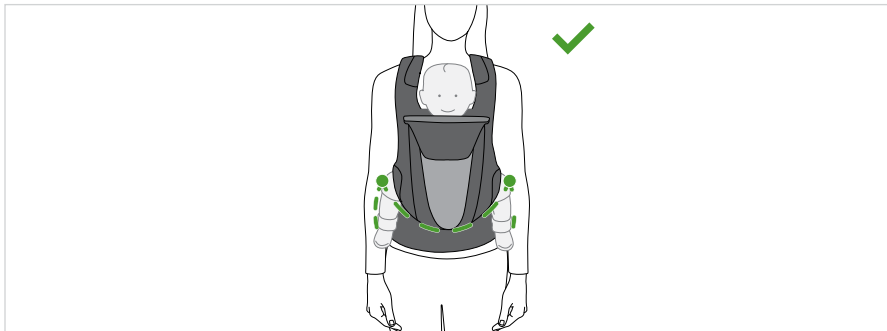

0 - 6 Mo.

Min. 3,2 kg (7 lb)



6 - 36 Mo.

Max. 15 kg (33 lb)



EN WARNING
DE WARNUNG
ES ADVERTENCIA
FR AVERTISSEMENT
PT AVISOS
IT ATTENZIONE
NL WAARSCHUWING
PL OSTRZEŻENIE
CS UPOZORNĚNÍ
SK UPOZORNENIE
SL OPOZORILO
HR UPOZORENJE
HU FIGYELMEZTETÉS
SE VARNING
NO ADVARSEL
FI VAROITUS
DA ADVARSEL
ET HOIATUS
LV BRĪDINĀJUMS
LT PERSPĖJIMAS
RU ВНИМАНИЕ
UK УВАГА
TR UYARI
EL ΠΡΟΕΙΔΟΠΟΙΗΣΗ
RO AVERTISMENTE
IS VIÐVÖRUN
MT TWISSIJA

AR
FA
YUE 警告
CMN 警告
JA 警告
KO 경고
BG ПРЕДУПРЕЖДЕНИЕ
SR UPOZORENJE
MS AMARAN
HI चेतावनी
TH คำเตือน
SQ PARALAJMËRIM
BS UPOZORENJE
ME UPOZORENJE
MK ПРЕДУПРЕДУВАЊЕ
HY ՉԳՈՒՇԱՑՈՒՄ
VI CẢNH BÁO

تحذير
اخطار



EN Tutorial video
DE Videoanleitung
ES Tutorial en video
FR Vidéo de démonstration
PT Video tutorial
IT Video tutorial
NL Instructievideo
PL Film instruktażowy
CS Výukové video
SK Výukové video
SL Video z navodili
HR Video s uputama
HU Bemutatóvideó
SE Videosjälvstudiekurs
NO Oppføringsvideo
FI Opetusvideo
DA Vejledende video
ET Õppevideo
LV Ar mācību video
LT Mokomasis vaizdo įrašas
RU Обучающее видео
UK Навчальне відео
TR Öğretici video
EL Εκπαιδευτικό βίντεο
RO Video tutorial
IS Kennslumyndband
MT Tutorial fuq vidjow

AR
FA
YUE 教程視頻
CMN 教程视频
JA チュートリアルビデオ
KO 튜토리얼 동영상
BG Учебно видео
SR Video sa uputstvima
MS Video tutorial
HI ट्यूटोरियल वीडियो
TH วีดีโอแนะนำ
SQ Video udhëzuese
BS Video sa uputstvima
ME Video sa uputstvima
MK Видеоупатство
HY Παιδαγωγικά βίντεο
VI Video hướng dẫn

فیدویو تعلیمی
ویدئوی آموزشی

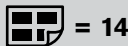

استخدام حلقة الساق
استفاده از حلقه پا

- EN** Using the Legloop
DE Verwendung der Beinschlaufe
ES Uso del lazo de la pierna
FR Utilisation de la boucle de jambe
PT Uso do laço da perna
IT Utilizzo della cinghia per la gamba
NL Gebruik van de beenlus
PL Użycie pętli na nogę
CS Použití nohavice smyčka
SK Použitie nohavice slučka
SL Uporaba nogo zanke
HR Korištenje petlje za nogu
HU A láb hurok használata
SE Användning av benöglå
NO Bruk av benløkken
FI Jalkalenkin käyttö
DA Brug af benløkke
ET Jala silmuse kasutamine
LV Izmantojot kāju cilpu
LT Naudodami kojų petį
RU Использование ножной петли
UK Використання нога петлі
TR Bacak halkası kullanarak
EL Χρησιμοποιώντας την πατούσα περιλούπα
RO Utilizând bucla pentru picior
IS Með að nota fótahringinn
MT B'uzu tal-irkoppa

- AR**
FA
YUE 使用腳環
CMN 使用腿環
JA 足ループの使用
KO 다리 루프 사용
BG Използване на краката петли
SR Koristeći petlju za nogu
MS Menggunakan gelang kaki
HI पैर का उपयोग
TH การใช้วงแขน
SQ Përdorimi i gajtës së këmbës
BS Koristeći petlju za nogu
ME Koristeći petlju za nogu
MK Користење на јамката за нога
HY Գրպետս որակ ուշադրուիթյունը
VI Sử dụng vòng chân

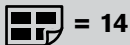

EN Using the Waist belt
DE Verwendung des Taillengurts
ES Uso del cinturón
FR Utilisation de la ceinture
PT Utilização do cinto abdominal
IT Utilizzo della cintura addominale
NL De taillegordel gebruiken
PL Korzystanie z pasa taliowego
CS Použití brňišního pásu
SK Používanie opasku
SL Uporaba pasu za okrog pasu
HR Korištenje pojasa za krilo
HU A deréköv használata
SE Använda midjebandet
NO Bruke midjebeltet
FI Lantiovyön käyttäminen
DA Brug af bælte
ET Võõrihma kasutamine
LV Vidukļa jostas izmantošana
LT Juosmens diržo naudojimas
RU Использование поясного ремня
UK Використання поясного ремня
TR Bel kemerinin kullanımı
EL Χρήση της ζώνης μέσης
RO Utilizarea centurii pentru talie
IS Að nota mittisbeltið
MT Kif tuża ċ-ċinturin tal-qadd

AR استخدام حزام الخصر
FA استفاده از کمربند
YUE 使用腰帶
CMN 使用腰带
JA 腰ベルトの使い方
KO 허리 벨트 사용
BG Използване на колана за кръста
SR Uпотреba pojasa za krilo
MS Menggunakan tali pinggang
HI वेस्ट बेल्ट का उपयोग करना
TH การใช้เข็มขัดคาดเอว
SQ Përdorimi i rripit të mesit
BS Korištenje pojasa za krilo
ME Korišćenje pojasa za krilo
MK Употреба на појасот за половина
HY Գոտկաւտեղի ամրագոտու օգտագործումը
VI Sử dụng đai thắt lưng

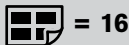

EN	Using the shoulder belt
DE	Verwendung des Schultergurts
ES	Uso del cinturón para los hombros
FR	Utilisation de la bretelle
PT	Utilização do cinto de ombro
IT	Utilizzo delle cinture
NL	De schoudergordel gebruiken
PL	Korzystanie z pasa barkowego
CS	Použití ramenního pásu
SK	Používanie ramenného pásu
SL	Uporaba ramenskega pasu
HR	Korištenje pojasa za ramena
HU	A vállöv használata
SE	Använda axelbandet
NO	Bruke skulderbeltet
FI	Olkahihnan käyttäminen
DA	Brug af skulderrem
ET	Õlarihma kasutamine
LV	Plecu siksnu izmantošana
LT	Diržo per petį naudojimas
RU	Использование плечевого ремня
UK	Використання плечевого ремня
TR	Omuz kemerinin kullanımı
EL	Χρήση της ζώνης ώμου
RO	Utilizarea centurii pentru umeri
IS	Að nota axlarbeltið
MT	Kif tuża ċ-ċinturin tal-ispalla

AR	استخدام حزام الكتف
FA	استفاده از بند شانه
YUE	使用肩帶
CMN	使用肩帶
JA	肩ベルトの使い方
KO	어깨 벨트 사용
BG	Използване на колана през рамото
SR	Upotreba pojasa za ramena
MS	Menggunakan tali pinggang bahu
HI	शोल्डर बेल्ट का उपयोग करना
TH	การใช้เข็มขัดคาดไหล่
SQ	Përdorimi i rripit të supave
BS	Korištenje pojasa za ramena
ME	Korišćenje pojasa za ramena
MK	Употреба на појасот за рамо
HY	Ուսադոսող ամրագոտող օգտագործումը
VI	Sử dụng đai vai



EN Using the neck support
DE Verwendung der Nackenstütze
ES Uso del soporte para el cuello
FR Utilisation de l'appui-nuque
PT Utilização do suporte do pescoço
IT Utilizzo del supporto per il collo
NL De nekondersteuning gebruiken
PL Korzystanie z podparcia szyi
CS Použití krční opěrky
SK Používanie podpery krku
SL Uporaba opore za vrat
HR Korištenje potpore za vrat
HU A nyaktámasz használata
SE Använda nackstödet
NO Bruke nakkestøtten
FI Niskatuen käyttäminen
DA Brug af nakkestøtte
ET Kaelatoe kasutamine
LV Kakla atbalsta izmantošana
LT Kaklo atramos naudojimas
RU Использование опоры для шеи
UK Використання підтримки шиї
TR Boyun desteğinin kullanımı
EL Χρήση του στηρίγματος αυχένα
RO Utilizarea suportului pentru ceafă
IS Að nota hálsstuðninginn
MT Kif tuża l-appoġġ għall-għonq

AR استخدام وسادة الرقبة
FA استفاده از ساپورت گردن
YUE 使用頸托
CMN 使用颈托
JA ネックサポートの使い方
KO 목 받침대 사용
BG Използване на опората за врата
SR Upotreba naslona za vrat
MS Menggunakan penyokong leher
HI नेक सपोर्ट का उपयोग करना
TH การใช้อุปกรณ์พยุงคอ
SQ Përdorimi i mbajtëses së qafës
BS Korištenje potpore za vrat
ME Korišćenje naslona za vrat
MK Употреба на потпирачот за вратот
HY Վզի հենասարքի օգտագործումը
VI Sử dụng tấm đỡ cổ

استخدام وسادة الرقبة
استفاده از ساپورت گردن

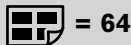

- EN** Using the storage bag
DE Verwendung der Aufbewahrungstasche
ES Uso de la bolsa de almacenamiento
FR Utilisation du sac de rangement
PT Utilização do saco de armazenamento
IT Utilizzo della borsa custodia
NL De opbergtas gebruiken
PL Korzystanie z torby do przechowywania
CS Použití úložné tašky
SK Používanie tašky na uskladnenie
SL Uporaba torbe za shranjevanje
HR Korištenje torbe za pohranu
HU A tárolózsák használata
SE Använda förvaringspåsen
NO Bruke oppbevaringsposen
FI Säilytyskassin käyttäminen
DA Brug af opbevaringstasken
ET Hoiukoti kasutamine
LV Uzglabāšanas somas izmantošana
LT Daiktų krepšio naudojimas
RU Использование сумки для хранения
UK Використання сумки для зберігання
TR Saklama çantasının kullanımı
EL Χρήση της τσάντας αποθήκευσης
RO Utilizarea genții de depozitare
IS Að nota geymslupokann
MT Kif tuża l-borża tal-ħażna

- AR** استخدام حقيبة التخزين
FA استفاده از کیف حمل و نگهداری
YUE 使用儲物袋
CMN 使用储物袋
JA 保管バッグの使い方
KO 보관 가방 사용
BG Използване на чантата за съхранение
SR Upotreba torbe za odlaganje
MS Menggunakan beg penyimpanan
HI स्टोरेज बैग का उपयोग करना
TH การใช้ถุงเก็บของ
SQ Përdorimi i çantës
BS Korištenje torbe za odlaganje
ME Korišćenje torbe za odlaganje
MK Употреба на торбата за складирање
HY Դիտպանման պարկի օգտագործումը
VI Sử dụng túi đựng

استخدام حقيبة التخزين
استفاده از کیف حمل و نگهداری



$$\text{Icon} = 20$$



$$\text{Icon} = 26$$



$$\text{Icon} = 27$$



$$\text{Icon} = 34$$



$$\text{Icon} = 36$$



$$\text{Icon} = 42$$



$$\text{Icon} = 44$$



$$\text{Icon} = 50$$



$$\text{Icon} = 52$$



$$\text{Icon} = 59$$

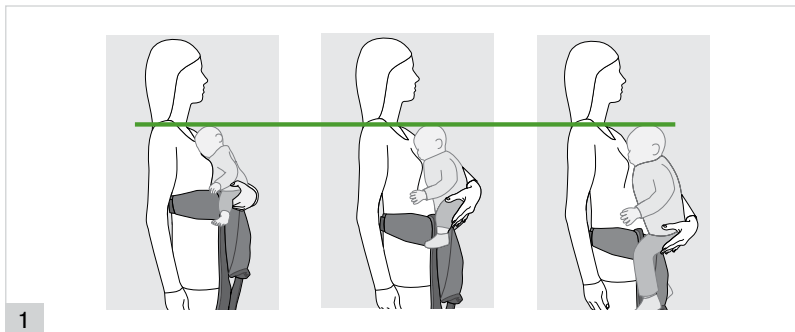
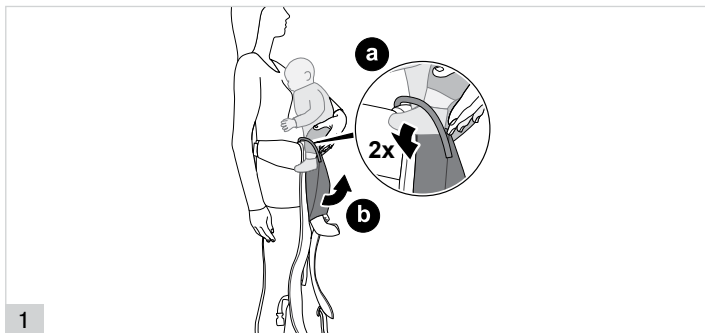

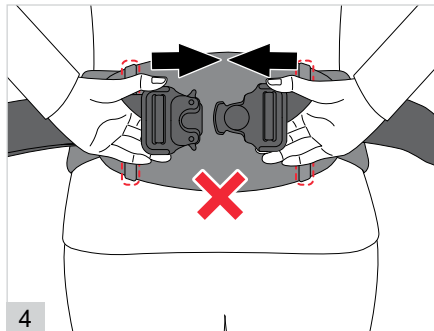
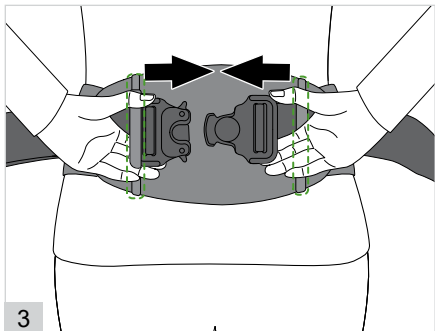
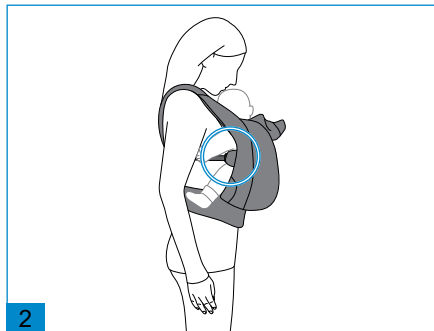
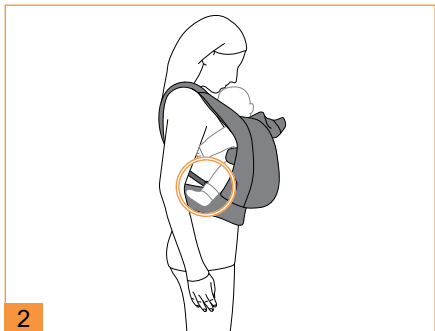

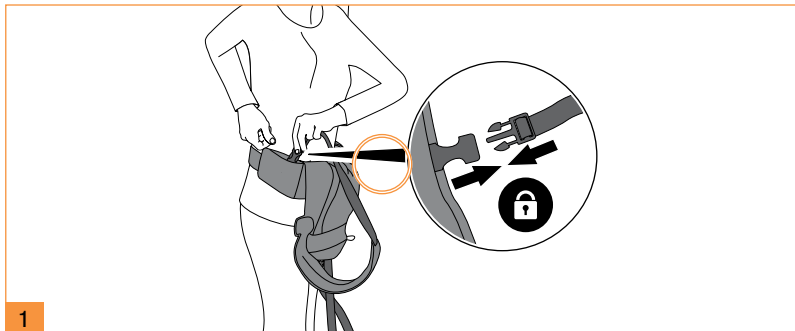
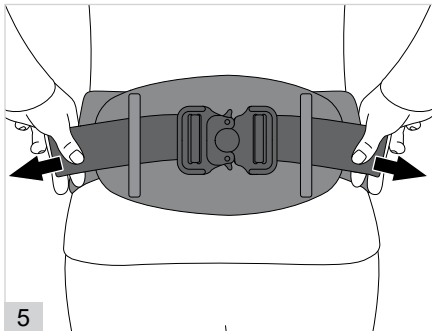

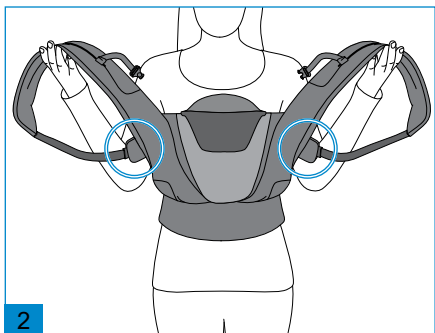
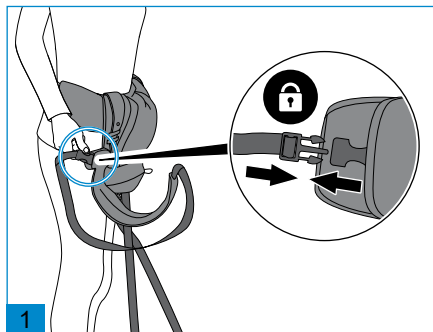
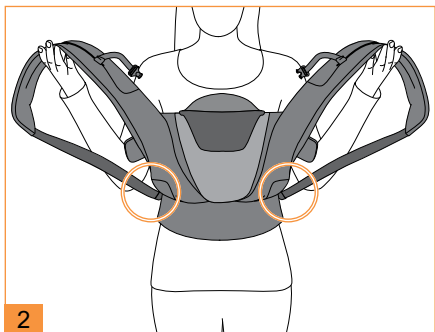

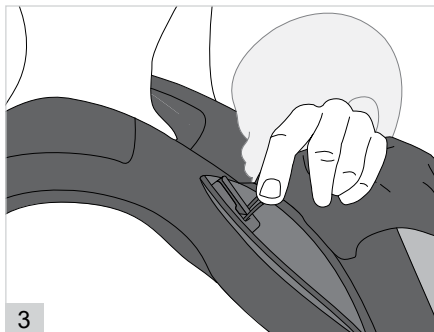
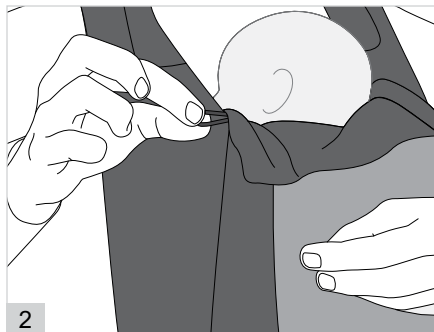

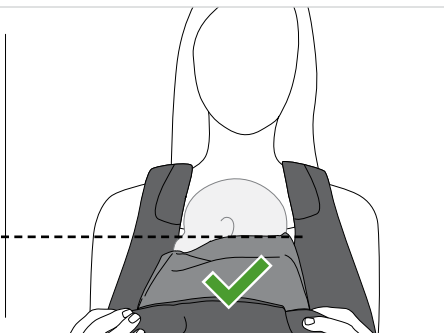
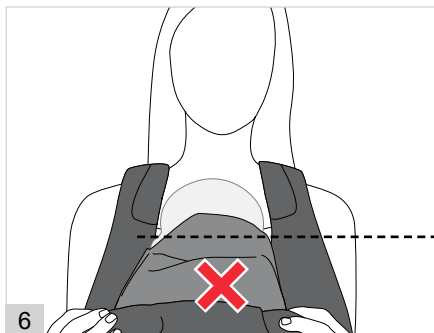
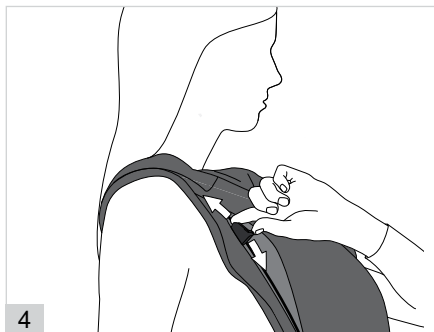

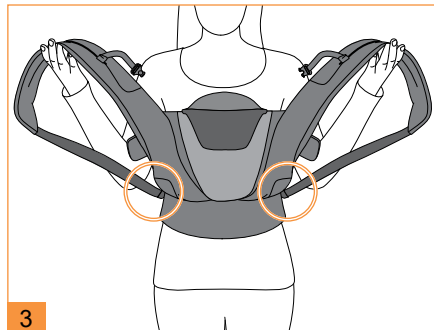
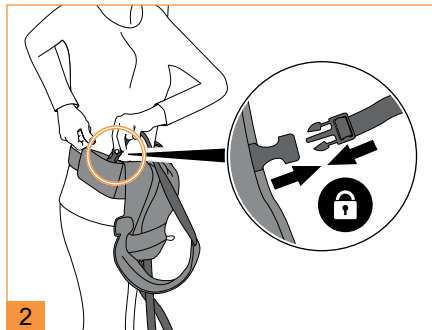
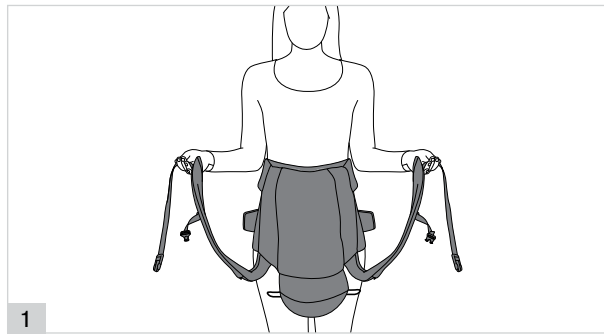
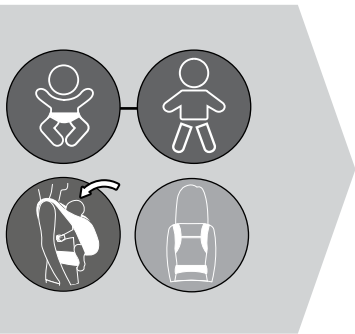

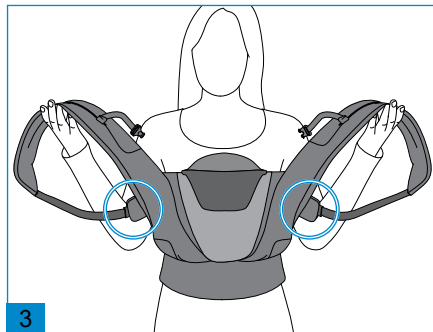
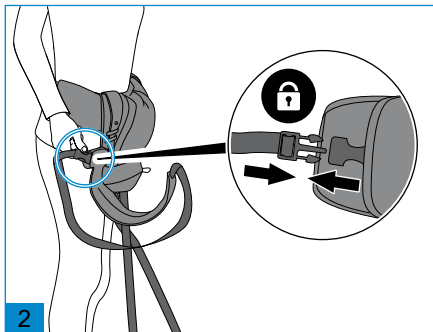

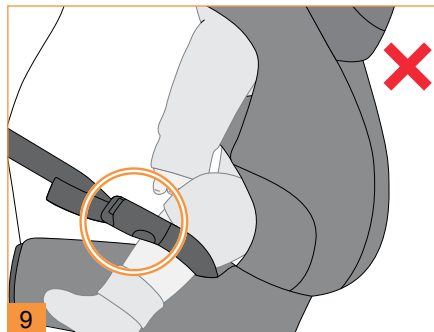
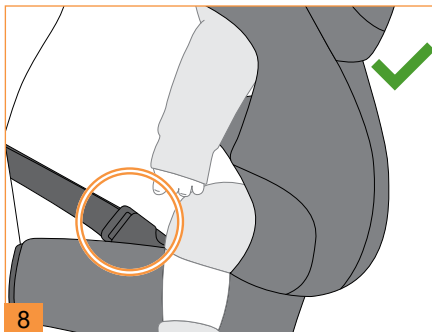

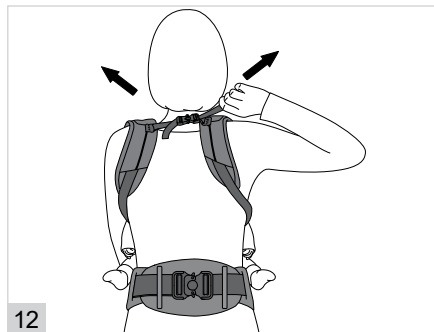
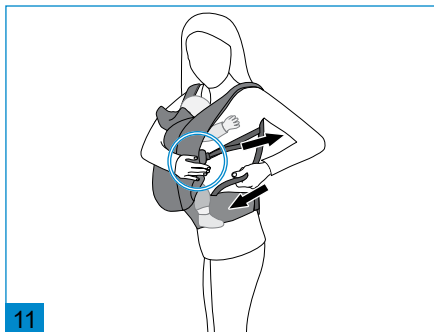
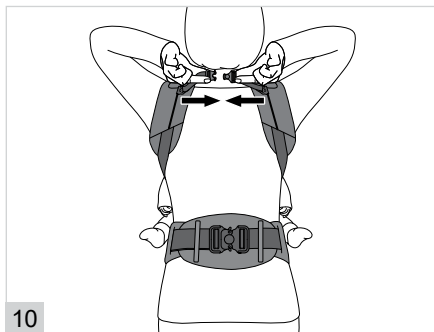

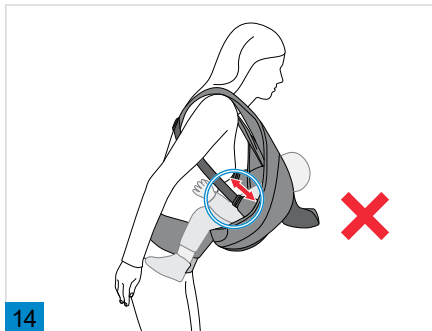
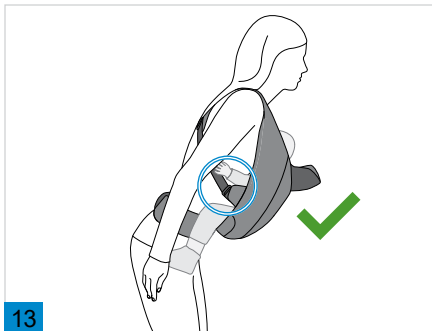
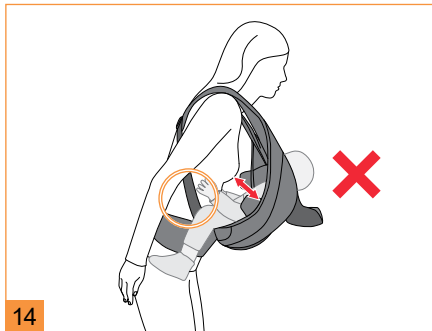
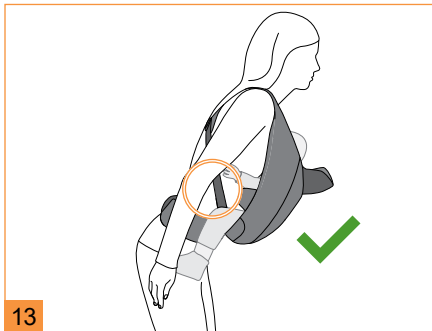

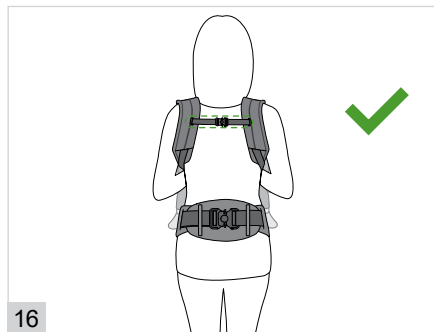

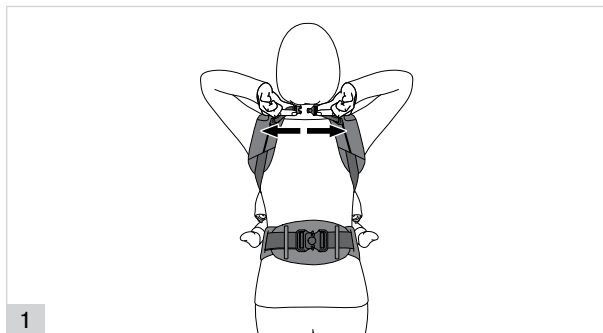

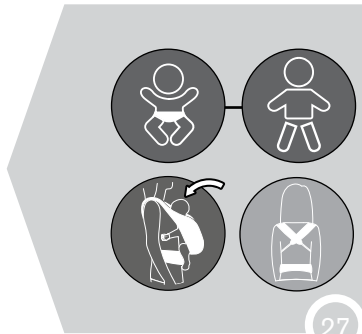
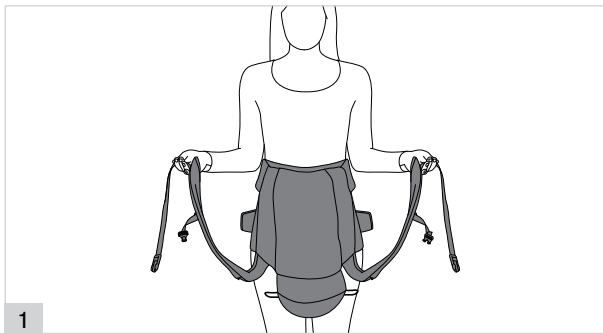
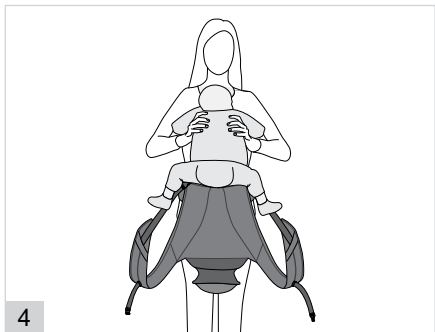

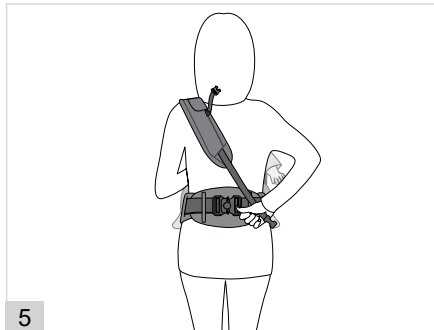

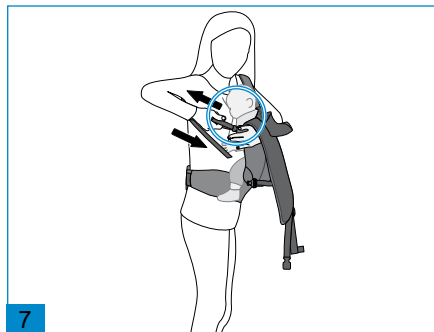
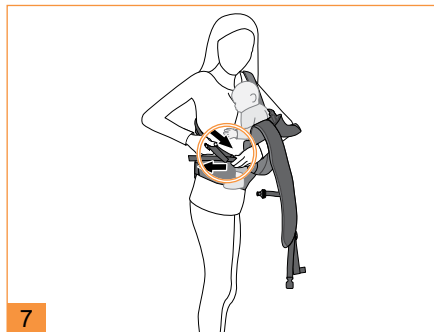

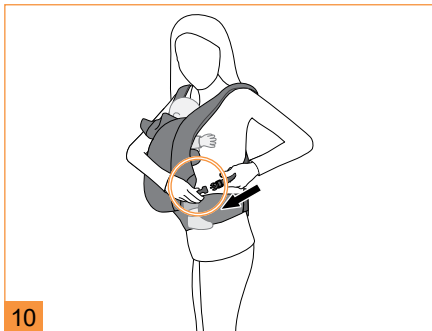
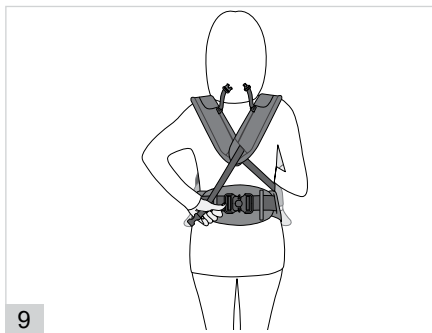

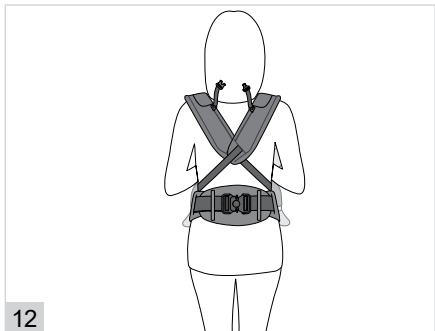
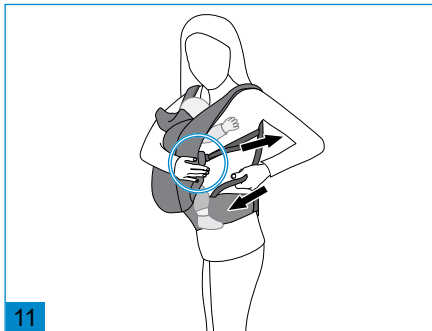
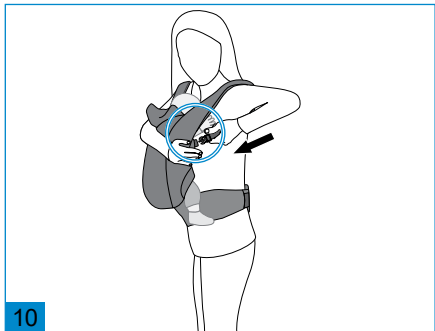

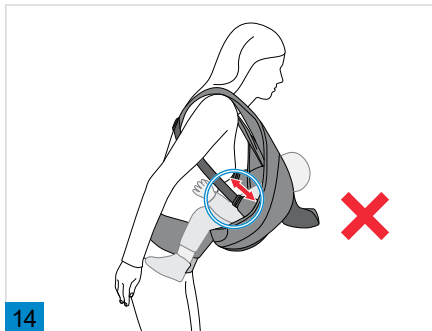
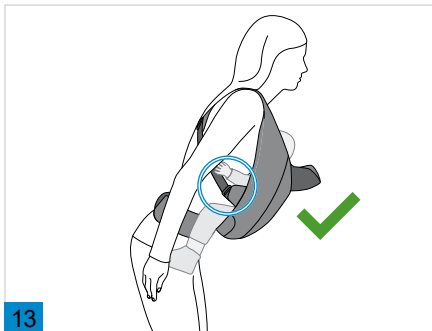
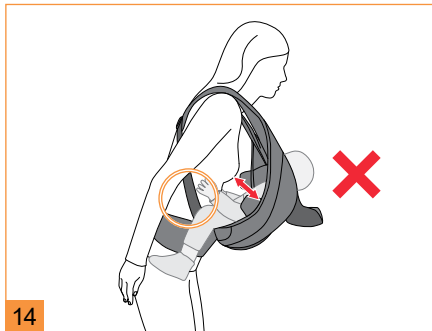
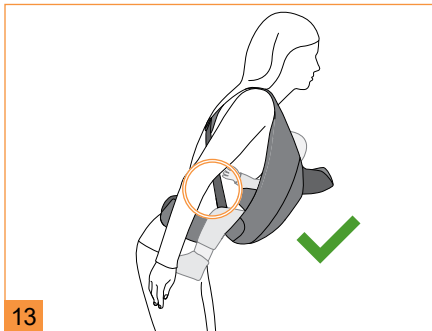

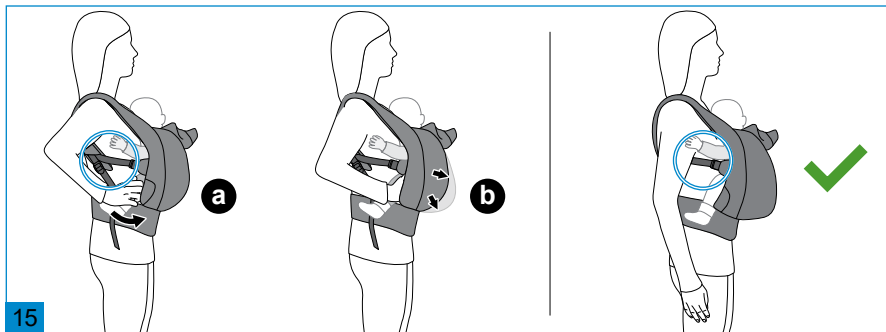
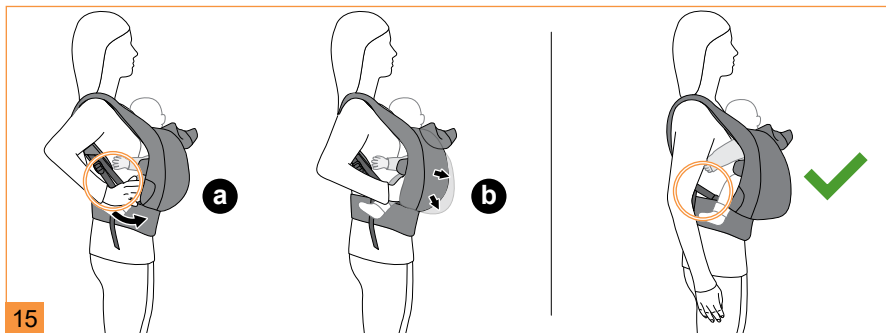

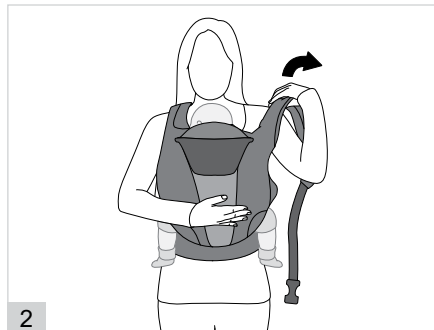
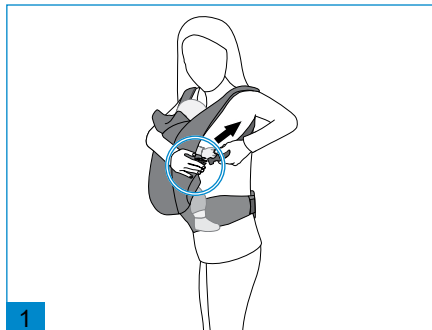
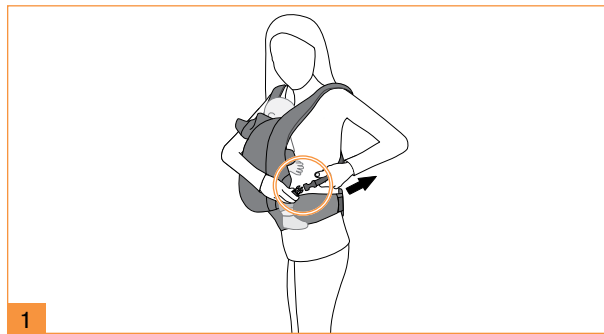
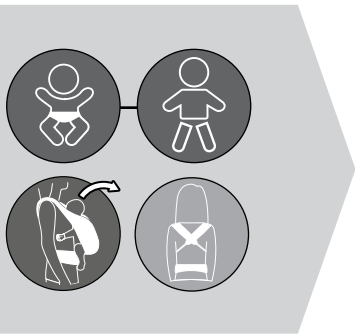

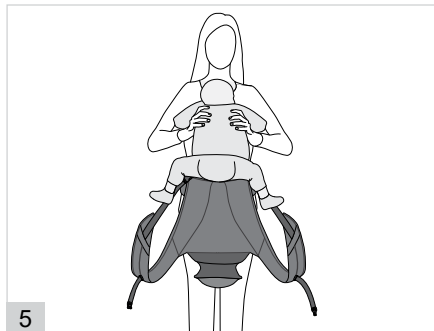

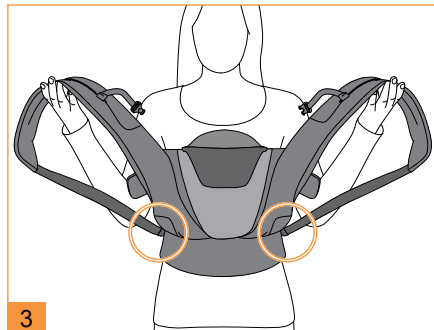
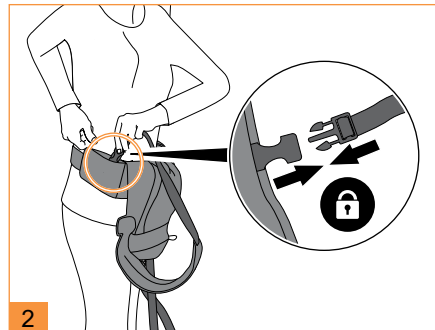
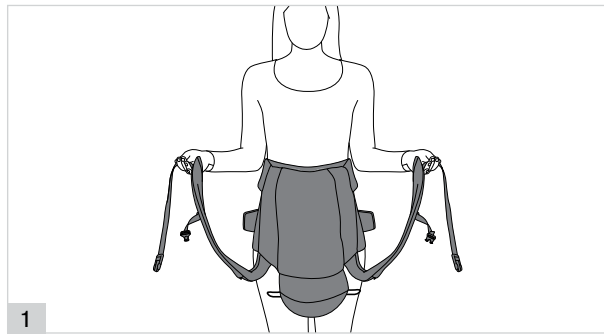
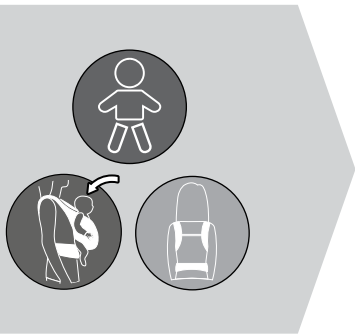

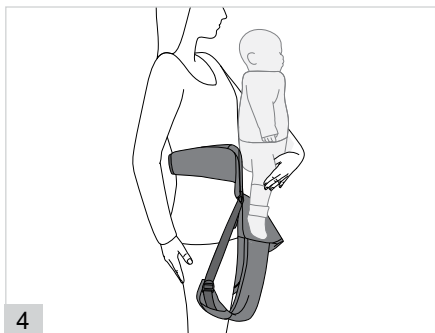
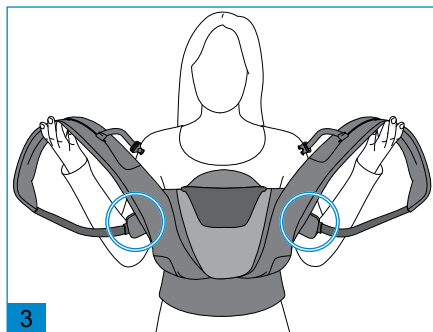
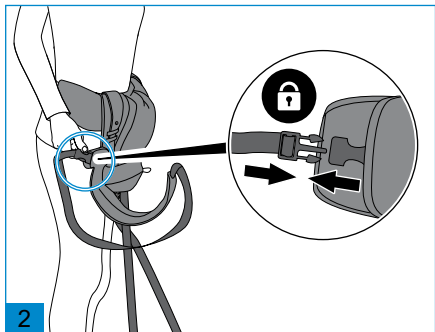

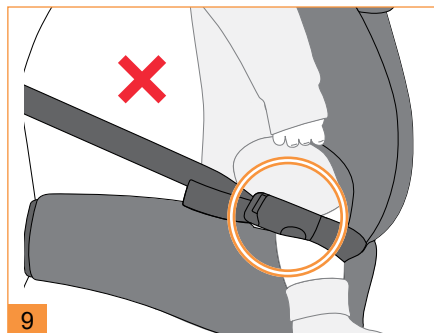
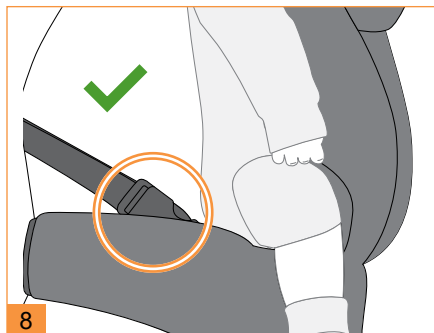

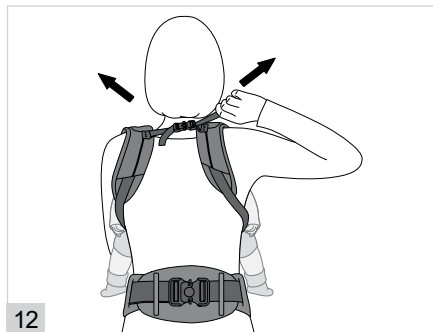
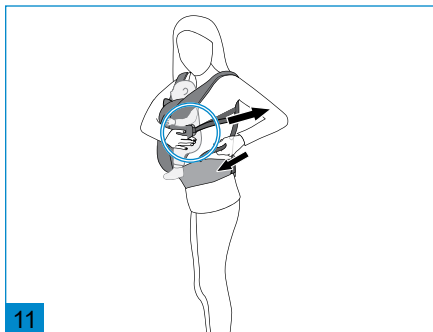
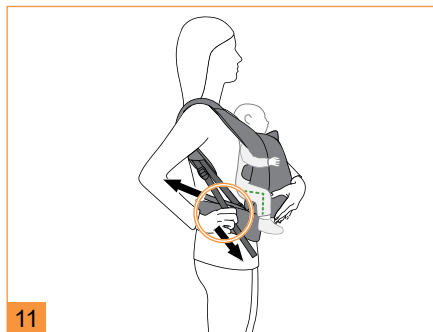
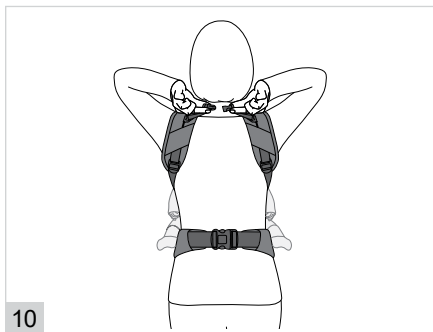

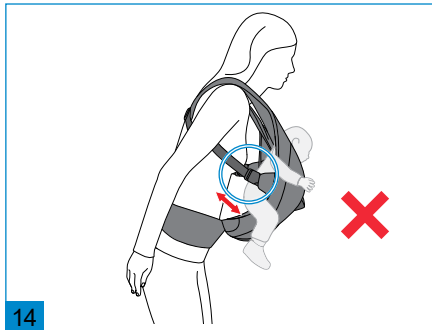
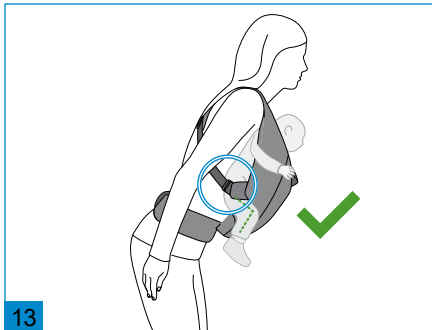
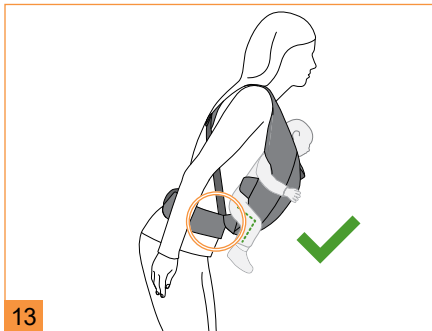

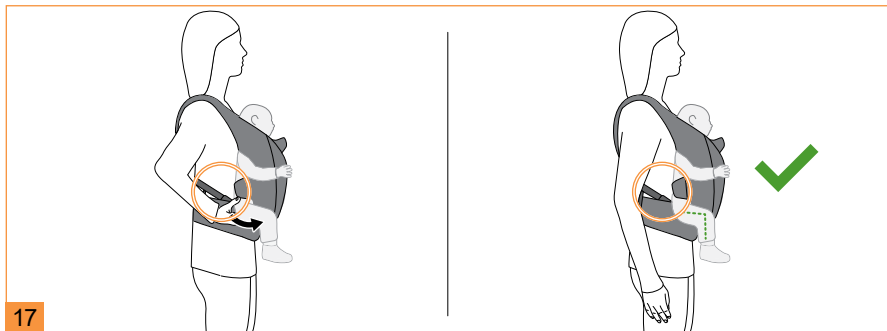
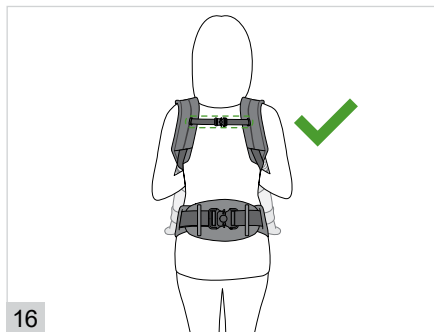
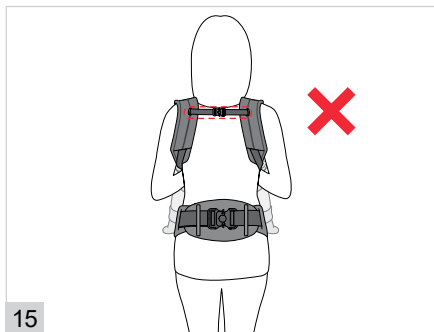

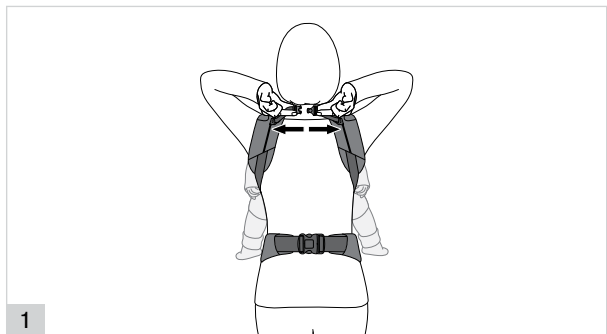
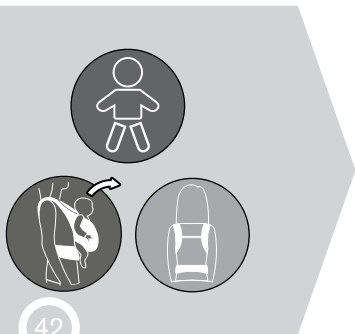

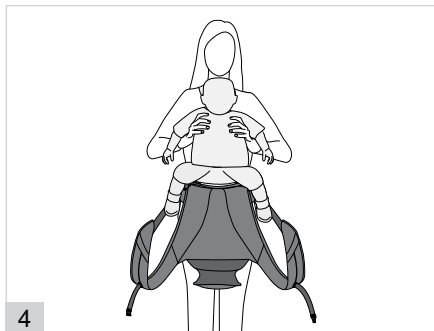

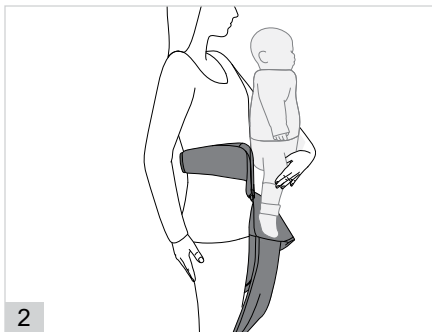
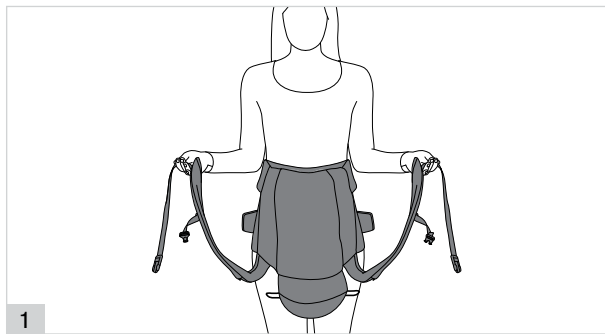
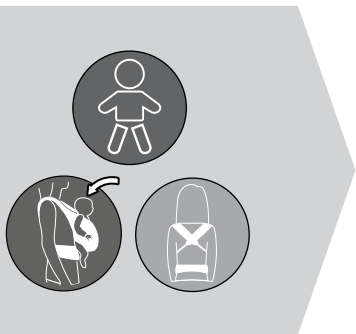

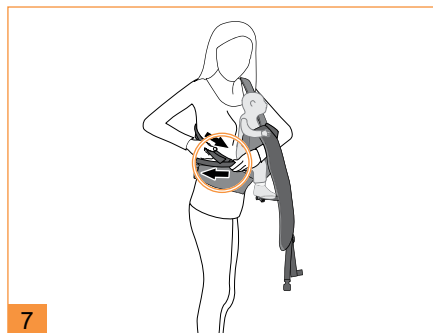
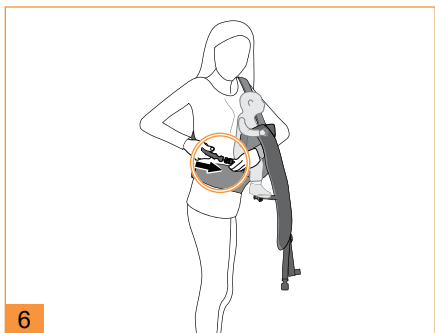
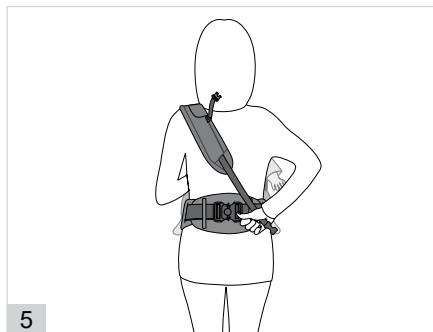
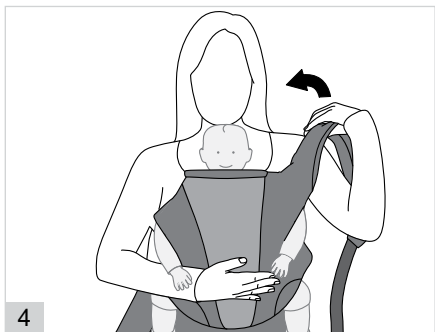

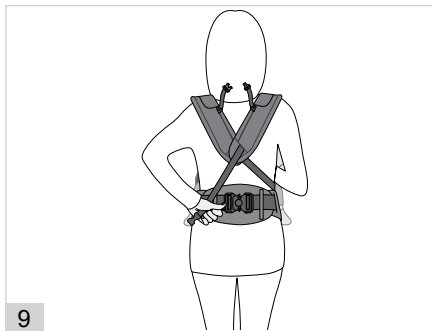
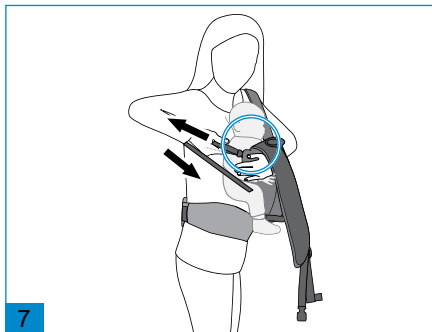
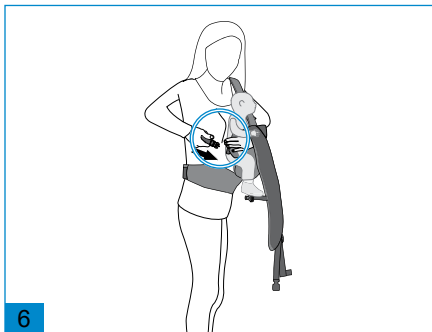

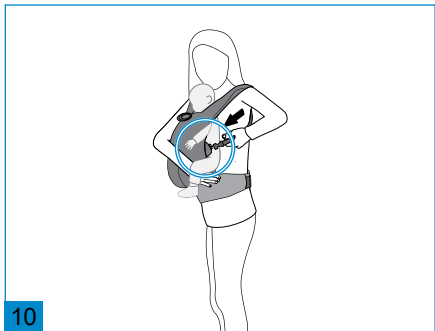

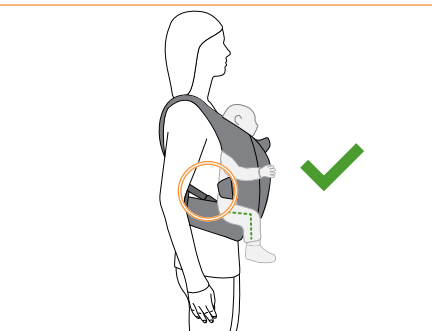
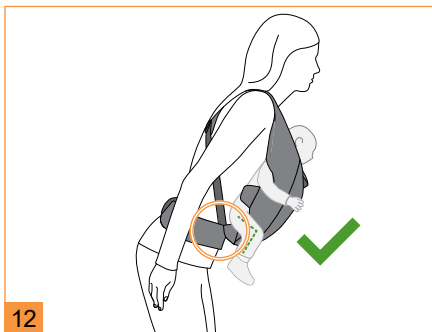

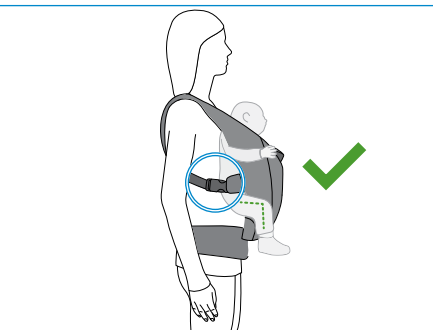
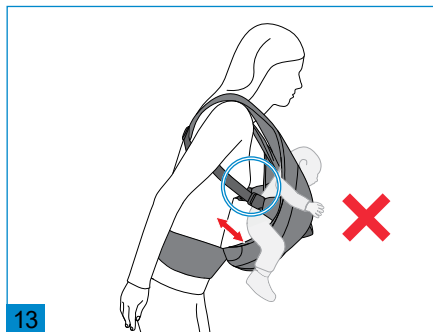
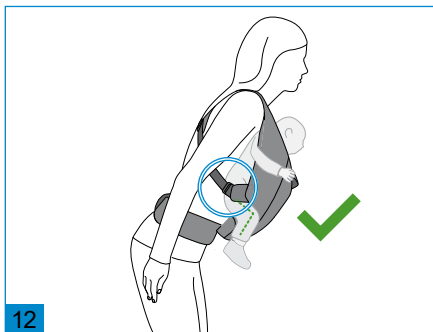

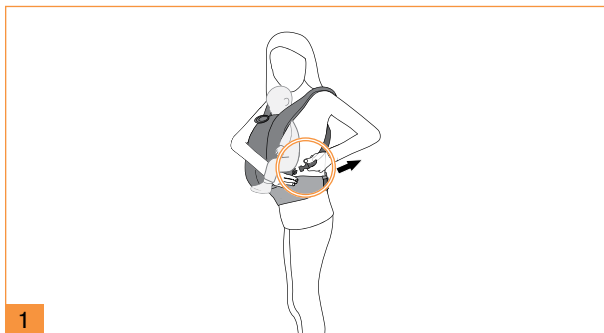
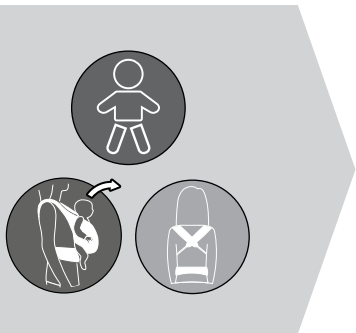

1

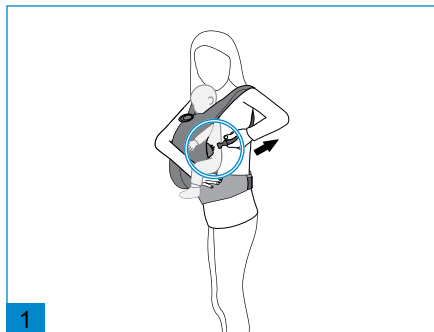

1



2

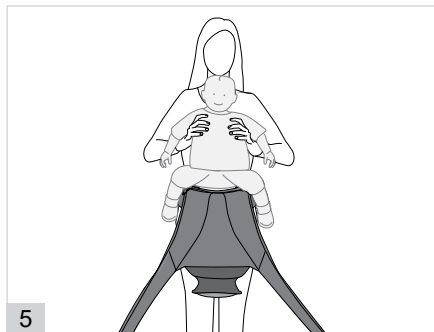
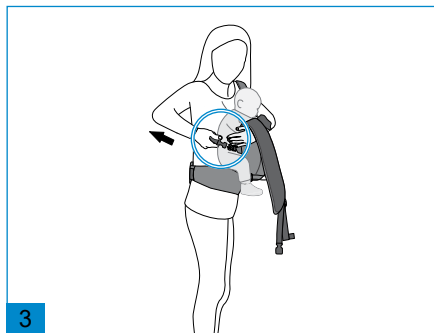
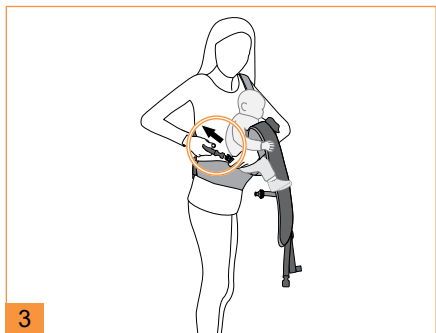

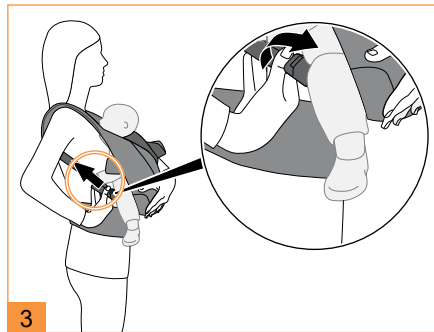
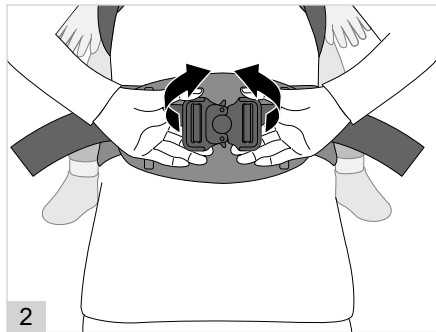
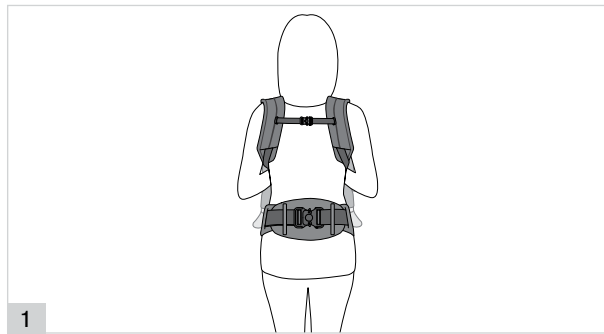
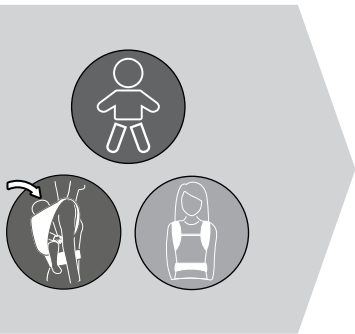

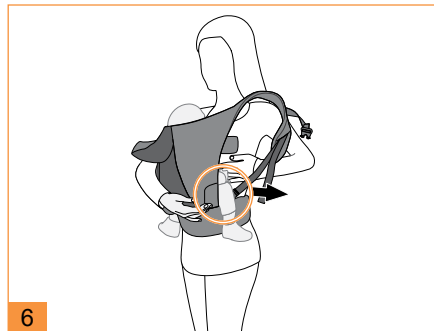

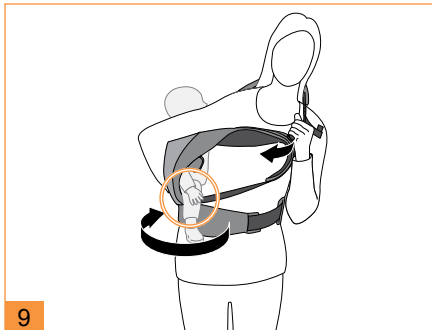
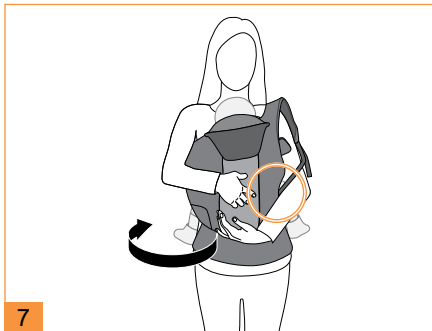

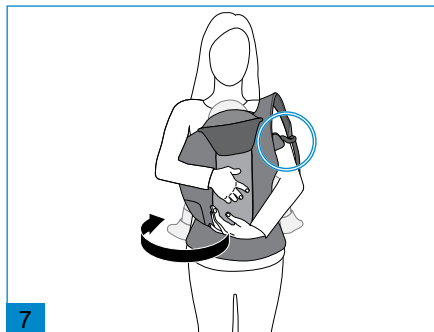
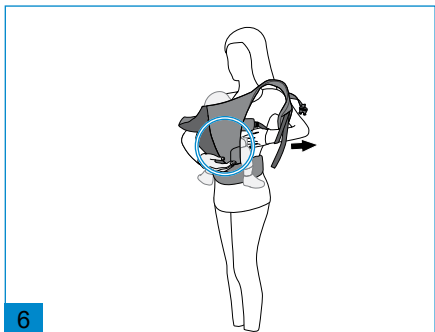
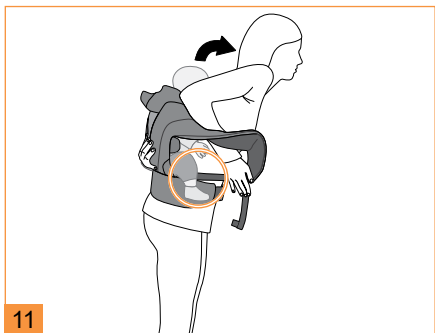

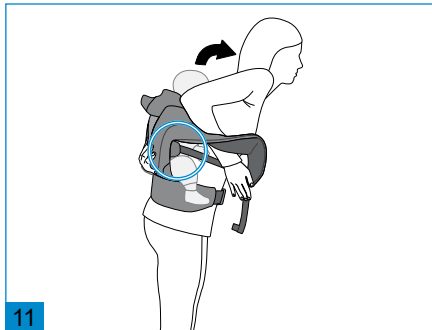
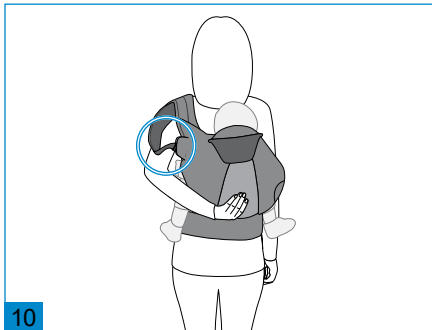
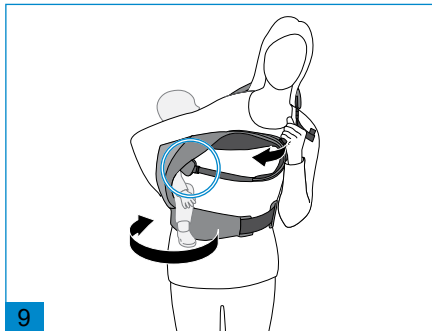
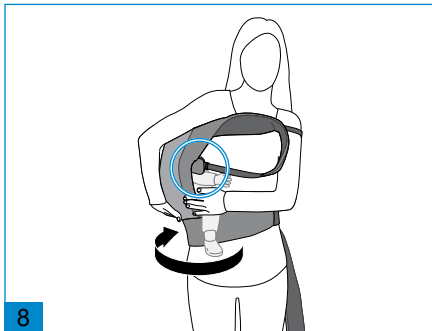

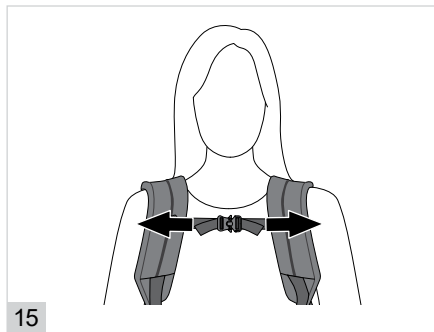
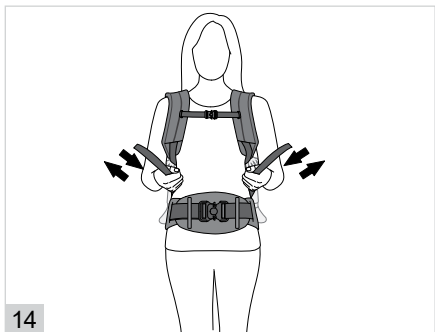
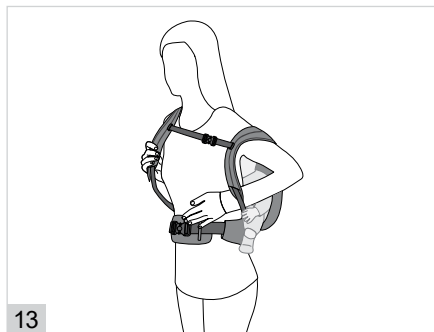

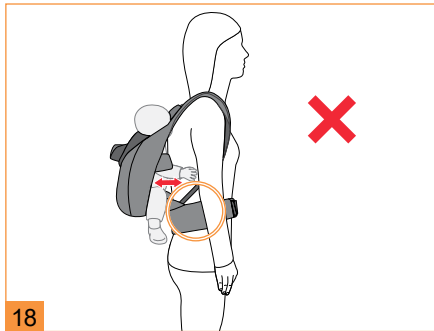
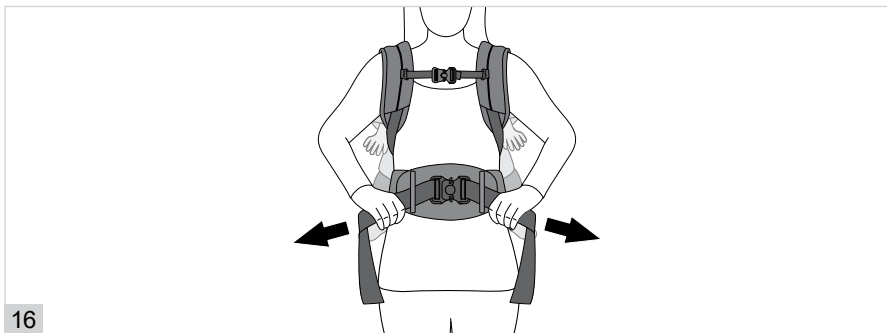

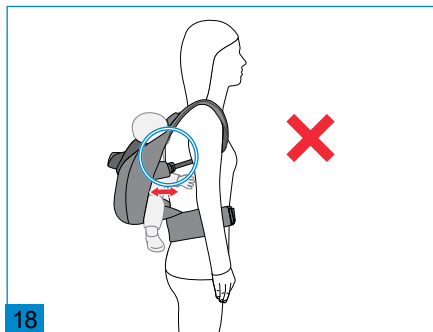
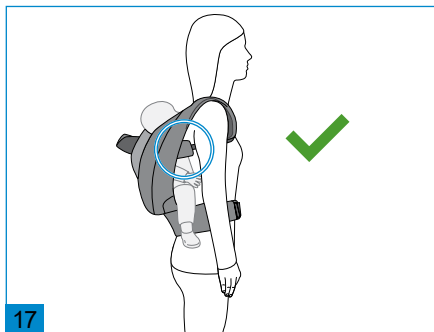

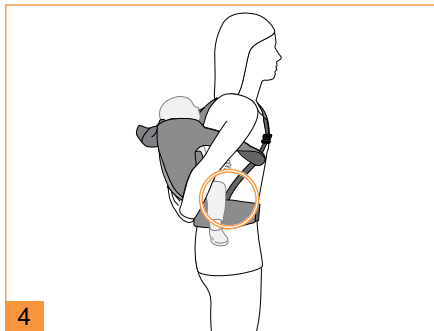
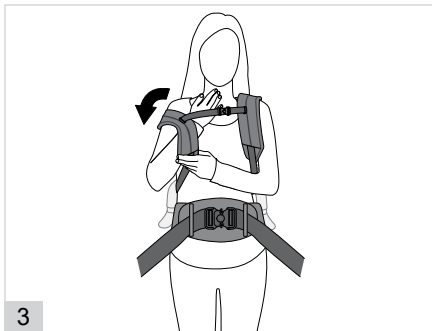
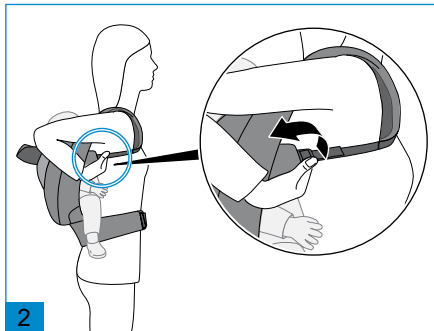
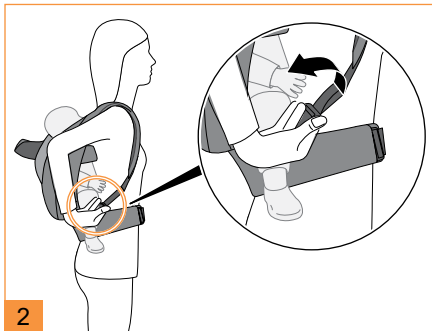

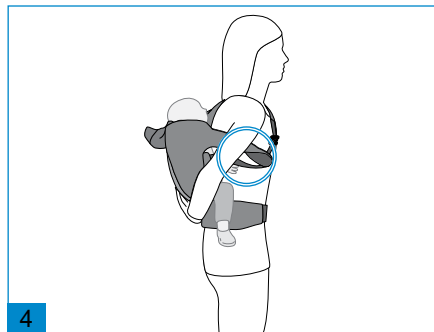
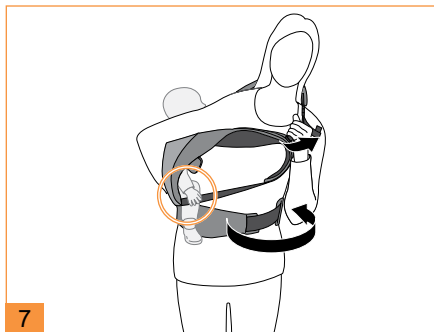
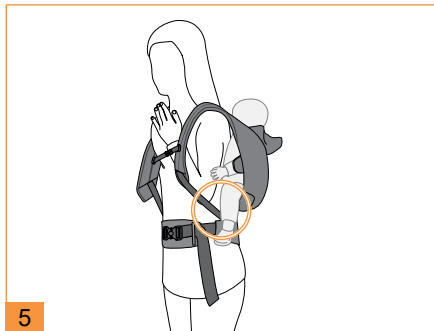

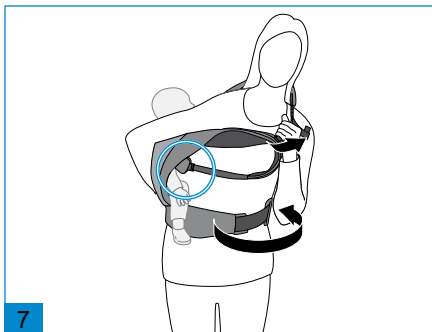
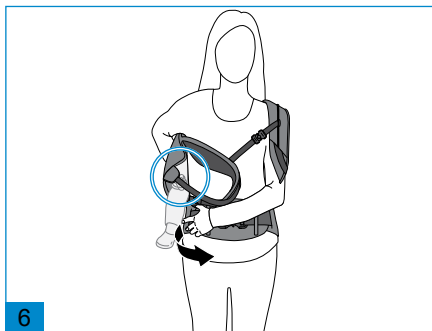
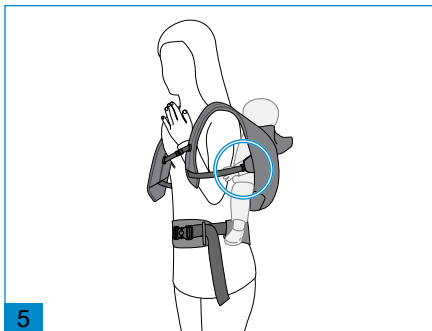

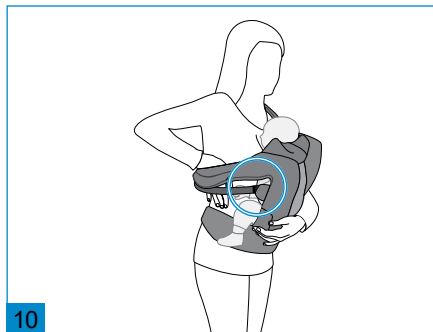
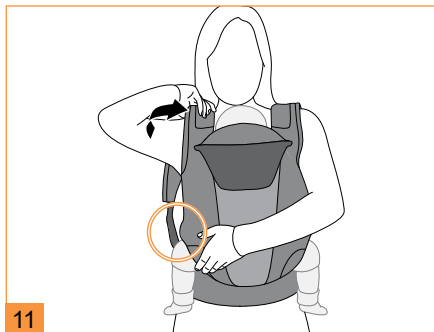
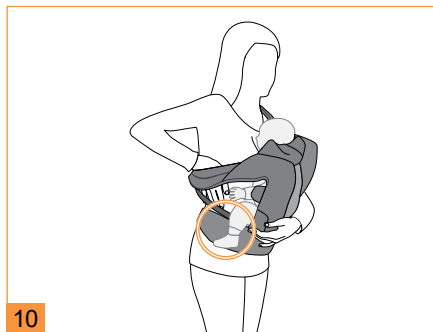

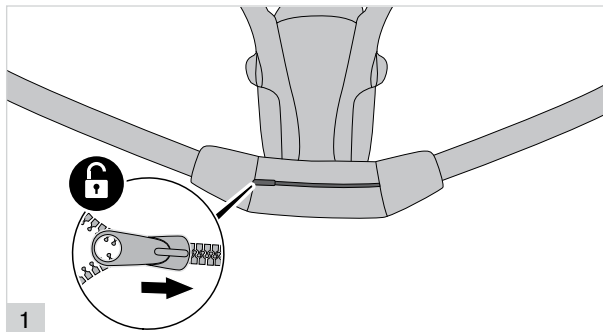
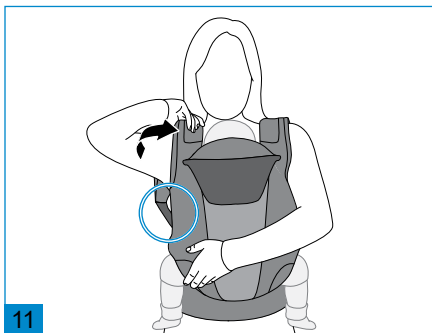

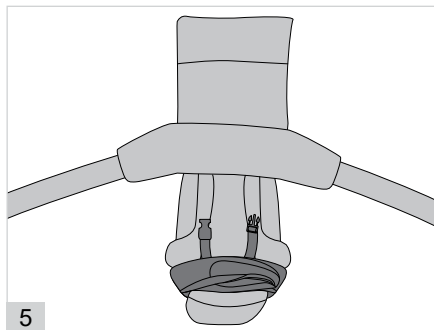
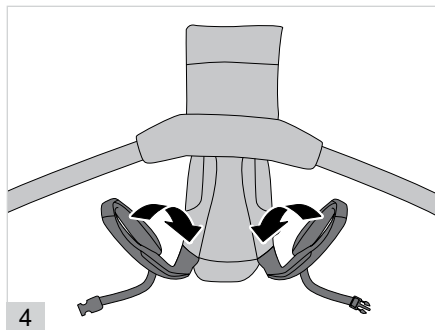
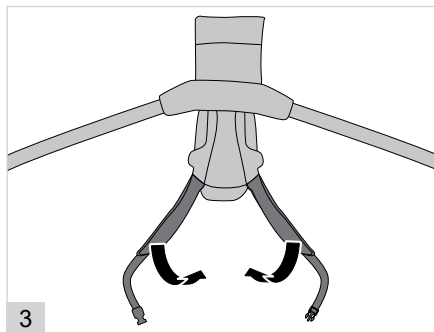
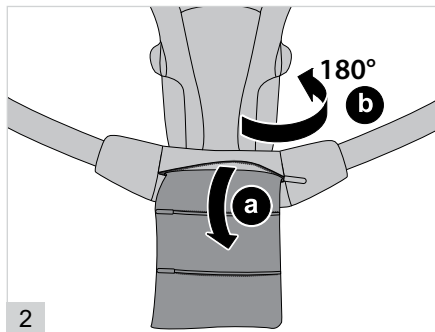

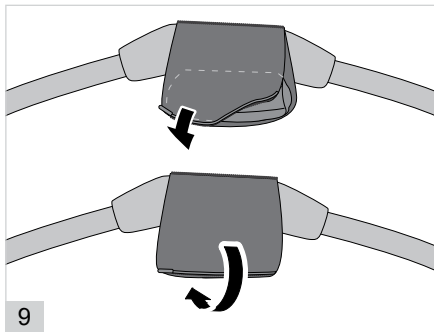
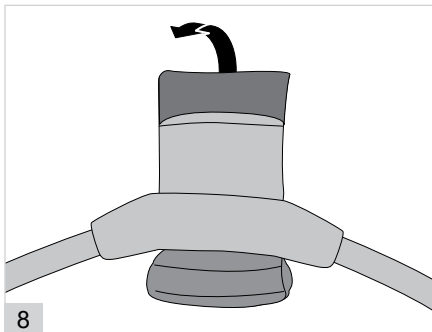
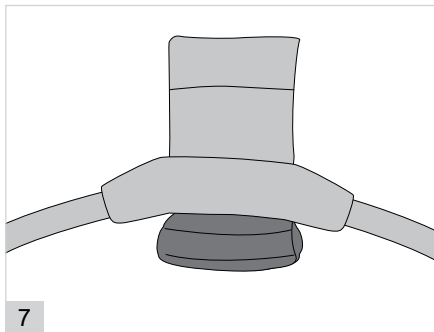
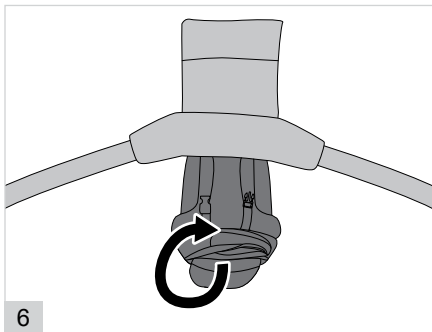

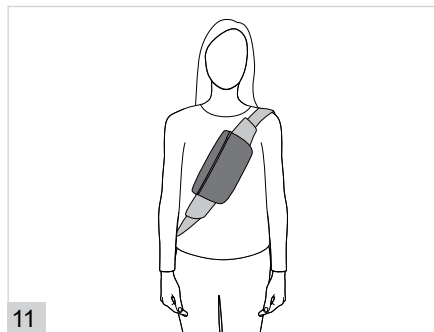
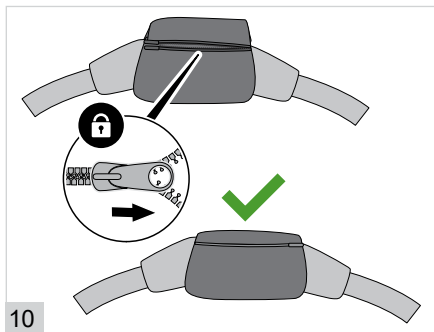



EUROPE AND ASIA

CYBEX GmbH
Riedingerstraße 18
95448 Bayreuth, Germany
+49 (0) 921-78 511 - 0
info@cybex-online.com

AMERICAS

Columbus Trading-Partners
USA Inc.
12915 Whitehall Park Drive,
Suite 300, Charlotte,
NC 28273, USA
Customer Service:
1-877-242-5676
info.us@cybex-online.com

CANADA

Goodbaby Canada Inc.
2 Robert Speck Parkway,
Suite 750
Mississauga, ON L4Z 1H8,
Canada
Customer Service:
1-877-242-5676
info.us@cybex-online.com

AUSTRALIA

Anstel Brands Pty Ltd
Sunline Drive 36
3029 Truganina, Victoria,
Australia
Phone: 03 9131 6545
support@anstel.com.au

NEW ZEALAND

Anstel Brands Pty Ltd
Sunline Drive 36
3029 Truganina, Victoria,
Australia
Phone: 09 886 0028
support@anstel.com.nz



FR

Cet appareil
et ses accessoires
se recyclent

REPRISE
À LA LIVRAISON



À DÉPOSER
EN MAGASIN



À DÉPOSER
EN DÉCHÈTERIE



OU

OU

Points de collecte sur www.quefairedemesdechets.fr